

NOVAS

1500 Door Closers

1500 Door Closers

1500 door closers are a power adjustable surface mounted hydraulic door closer. Applications include regular arm, parallel arm, top jamb, track arm, delayed action and adjustable back check function.



Door Closer Selection Chart

Size	Regular Arm/Top Jamb			Parallel Arm/Track Arm			Door Weight Kg.
	Interior Door	Exterior Door		Interior Door	Exterior Door		
		Swing In	Swing Out		Swing In	Swing Out	
2	900	800	700	800	700	600	25-45
3	1050	900	800	900	800	700	40-60
4	1200	1050	900	1050	900	800	55-75
5	1350	1200	1050	1200	1050	900	70-90

Maximum door width dimension in mm

Door Closer Applications

Mounting Details

Regular Arm Installation

Closer is fixed to the pull (hinge) side of the door.

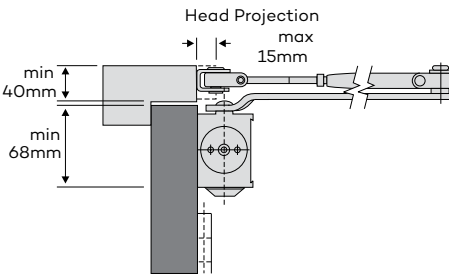

Parallel Arm Installation

Closer is fixed to the push (opposite to hinge) side of the door.

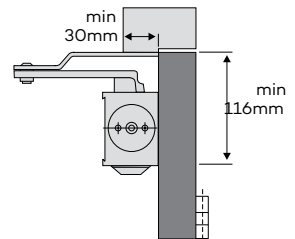

Top Jamb Installation

Closer is fixed to the Top Jamb on the push (opposite to hinge) side of the door.

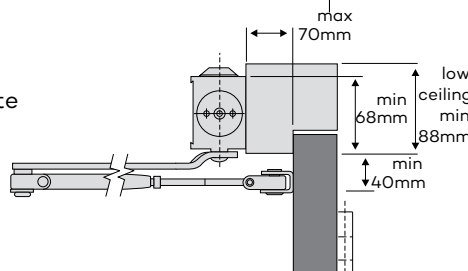

Regular Track Arm Installation

Closer is fixed to the pull (hinge) side of the door.

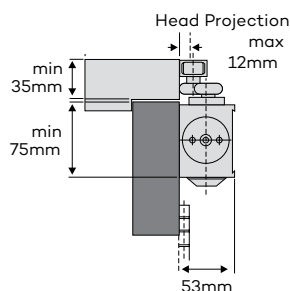

Top Jamb Track Installation

Closer is fixed to the Top Jamb on the pull (hinge) side of the door.

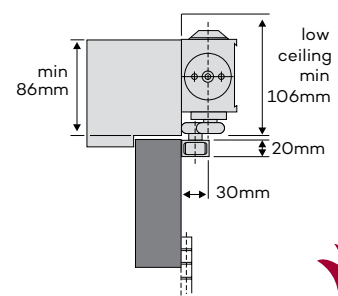

Fire Rated

NOVAS

1500 Door Closers

Technical Data – Limiting Dimensions

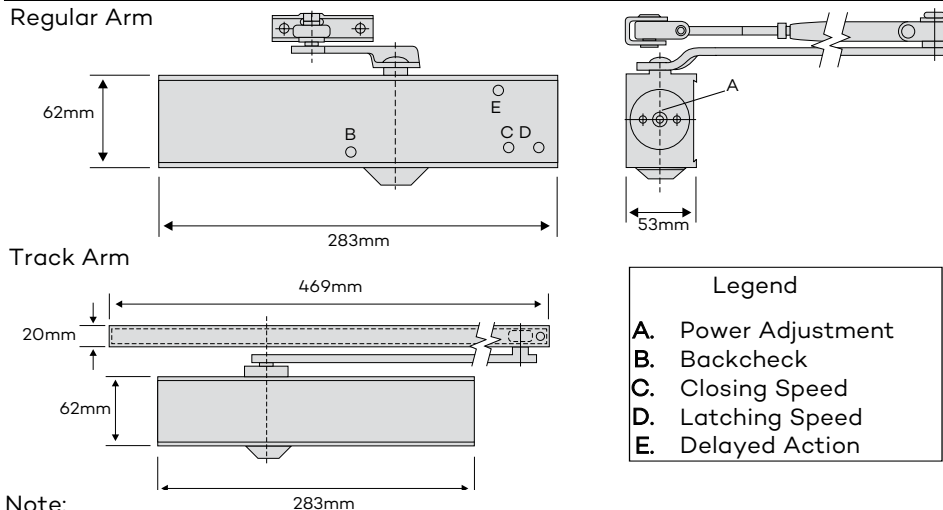

Note:

Specification of track arm and parallel arm applications should consider the single strength reduction in power.

A. Power Adjustment

Simple adjustment by rotation of a captive screw adjusts the size of the closer to the desired strength. 1500BC (size 2-5), 1500DA and 1500TR (size 1-4).

B. Backcheck

Adjustable backcheck provides cushioning effect on opening to give protection to the door and fittings.

C. Closing Speed

Captive valve is conveniently located on the face of the door closer to control the closing speed.

D. Latching Speed

A separate adjustment valve to accelerate or decelerate the door to ensure positive latching.

E. Delayed Action

Delays the closing action of the door to allow slow moving traffic to pass.

Adjustment Details

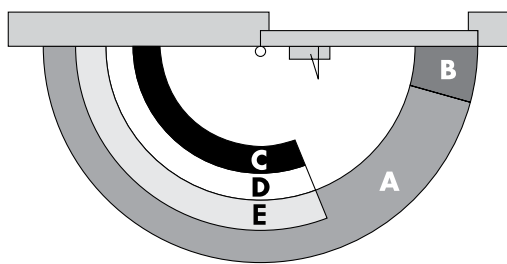

A	Closing Range	15 ° - 180 °
B	Latching Range	0° - 15 °
C	Backcheck Range	70 ° - 180 °
D	Hold Open Range	70 ° - 180 °
E	Delayed Action	70 ° - 180 °

Ordering Procedure

Cat. No.	Description	Door	Finish
1500BC	Door Closer Adj (2-5)	Door	SIL/SSS/PSS
1500DA	Closer Adj (1-4)		SIL/SSS/PSS
1500VTRB	Track Arm Door Closer (1-4)		SIL/SSS/PSS

Accessories to suit 1500 Series Closer

1500 - 10	Hold Arm Open to	SIL
1500 - 11	suit Track Arm	SIL
1500 - 20	Assembly Drop Plate	SIL
1500 - 30	to suit Parallel Arm	SIL
1500 - 40	Bracket Cover	SSS/PSS

Finish

SIL	Silver
SSS	Satin Stainless Steel
PSS	Polished Stainless Steel

Mechanism & Case

High Pressure diecast aluminium body, rack and pinion hydraulic controlled piston door closer. Reversible for left-hand and right-hand doors.

Fire Rating

FIRE DOORS

Approved on fire door assemblies up to 2 hours in accordance with Australian Standard AS 1905 - Part 1 - Fire resistant door sets.



Fire Rated

NOVAS

Novas Door Controls

Novas Hydraulic door closers are designed to suit various residential and commercial applications. By definition, door closers are used to close hinged leaf doors after they have been manually opened. The smooth closing operation is controlled by the adjustable hydraulic rack and pinion mechanism.

In choosing a closer style for a particular application consideration should be given to the type of door being controlled, frame condition, aesthetic and the control features required by the end user.

The size and weight of the door is the main consideration in selecting a closer of the correct strength. Recommended door widths for each closer assume normal operating conditions. If a door is of exceptional height, weight, special construction, or if air pressure differentials exist, a more powerful closer should be considered.

A door closer effectively increases the loading on door hinges and their rate of wear. It is recommended that any door fitted with a door closer should use three or more Novas Ball Bearing/Sintered Bearing Hinges.

It is essential that the door be clear in the door frame and when fitted with a lock the latch bolt must engage freely with the strike.

Floor or wall mounted doorstops should be fitted to prevent possible damage to the door frame and fitted hardware.

Services

Novas Architectural offers a fully comprehensive (free of charge) specification/door scheduling service to meet Project requirements. Door schedules are prepared by our scheduling team who are all design and/or industry trained professionals. Please contact your local Novas Architectural representative for assistance.

Guarantee

Novas Architectural guarantee all their products against defects in workmanship and materials subject to inspection and confirmation of fair wear and tear within the normal working life of the product.

Novas Architectural assumes no liability for:

1. Improper installation or failure to follow fitting instructions.
2. Product failure due to improper maintenance or unfair wear and tear.
3. Indirect or consequential loss or damage.
4. Cost of removal and/or replacement.
5. Cost of freight and/or travelling expenses.
6. Some plated finishes are classified as soft finishes. Deterioration is possible under some climatic conditions and cannot be unconditionally guaranteed.

Consult your local Novas Architectural Representative or Agent for advice on all finishes.